

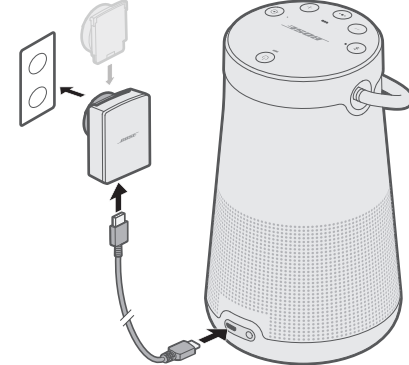





## SOUNDLINK REVOLVE + II



1. Connect to power.
2. Press .

1. Schließen Sie den Lautsprecher an den Strom an.
2. Drücken Sie .

1. Conecte a la alimentación.
2. Presione .

1. Raccordez l'enceinte à la prise secteur.
2. Appuyez sur la touche .

①

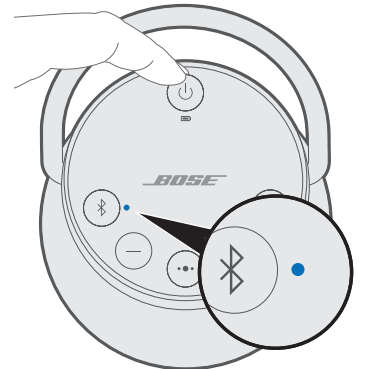



1. Collegare all'alimentazione.
2. Premere .

1. Conecte à energia.
2. Pressione .

1. Anslut till en strömkälla.
2. Tryck på .

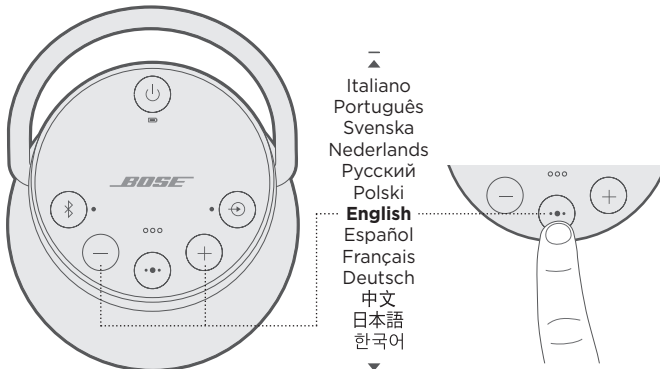
②



1. Press - or + to scroll through available languages.
2. Press and hold  to select your language.

1. Drücken Sie - oder +, um durch die verfügbaren Sprachen zu blättern.
2. Halten Sie zum Auswählen der Sprache  gedrückt.

1. Presione - o + para desplazarse por los idiomas.
2. Mantenga presionado  para seleccionar el idioma.

1. Appuyez sur - ou + pour faire défiler les langues.
2. Maintenez enfoncée la touche  pour sélectionner votre langue.

Italiano  
Português  
Svenska  
Nederlands  
Русский  
Polski  
**English**  
Español  
Français  
Deutsch  
中文  
日本語  
한국어

1. Premere - o + per scorrere l'elenco delle lingue disponibili.
2. Tenere premuto  per selezionare la propria lingua.

1. Pressione - ou + para navegar pelos idiomas disponíveis.
2. Pressione  por alguns segundos para selecionar seu idioma.

1. Tryck på - eller + för att rulla i språklistan.
2. Tryck och håll ned  för att välja språk.

③

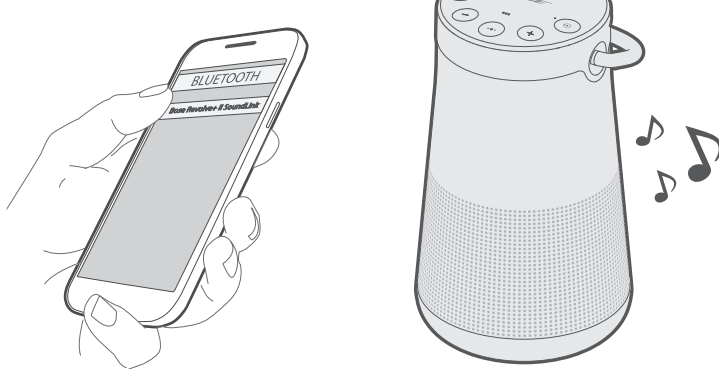

1. Select **Bose Revolve+ II SoundLink**.
2. Play music.

1. Wählen Sie **Bose Revolve+ II SoundLink**.
2. Musikwiedergabe.

1. Seleccione **Bose Revolve+ II SoundLink**.
2. Reproduzca música.

1. Sélectionnez **Bose Revolve+ II SoundLink**.
2. Démarrez la lecture.

1. Selezionare **Bose Revolve+ II SoundLink**.
2. Riprodurre la musica.

1. Seleccione **Bose Revolve+ II SoundLink**.
2. Reproduza músicas.

1. Välj **Bose Revolve+ II SoundLink**.
2. Spela musik.

Download the free Bose® Connect app to easily manage *Bluetooth*® connections, unlock features, and access future updates.

Laden Sie die kostenlose Bose® Connect App herunter, um *Bluetooth*®-Verbindungen ganz einfach zu verwalten, erweiterte Funktionen freizuschalten und zukünftige Aktualisierungen zu nutzen.

Descargue la aplicación Bose® Connect gratuita para controlar fácilmente las conexiones *Bluetooth*®, activar funciones y acceder a futuras actualizaciones.

Téléchargez l'application Bose® Connect gratuite pour gérer vos connexions *Bluetooth*®, déverrouiller certaines fonctionnalités et accéder aux prochaines mises à jour, en toute simplicité.

Scaricare l'app gratuita Bose® Connect per gestire le connessioni *Bluetooth*® con semplicità, sbloccare funzionalità e ricevere aggiornamenti in futuro.

Baixe o aplicativo gratuito Bose® Connect para gerenciar conexões *Bluetooth*®, desbloquear recursos e acessar atualizações futuras facilmente.

Hämta appen Bose® Connect för att enkelt hantera *Bluetooth*®-enheter, låsa upp funktioner och få tillgång till framtida uppdateringar.



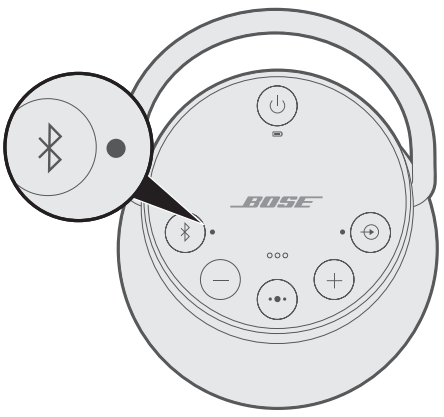
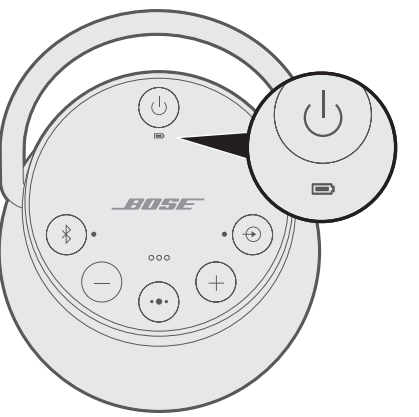
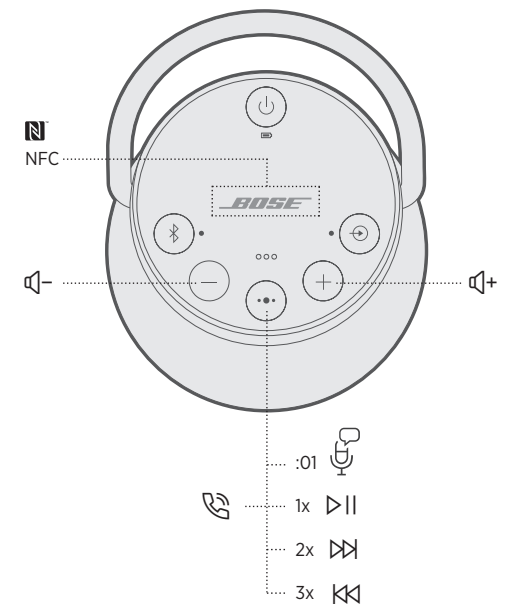

[worldwide.bose.com/Support/SLRPii](https://worldwide.bose.com/Support/SLRPii)



- |   |   |  |   |
|---|---|--|---|
|   |   |  |   |
| Medium to full charge<br>Halb bis voll aufgeladen<br>Carga media a completa<br>Charge moyenne ou complète<br>Bateria da mediamente a completamente carica<br>Carga média a total<br>Mellan till full laddning | Charging<br>Aufladen<br>Cargando<br>En cours de charge<br>Carica in corso<br><br>Carregando<br>Laddar | Medium charge<br>Mittlere Aufladung<br>Carga media<br>Charge moyenne<br>Carica media<br><br>Carga média<br>Laddat till hälften | Need to charge<br>Aufladen erforderlich<br>Se necesita cargar<br>Charge nécessaire<br>La batteria ha bisogno di essere ricaricata<br>Carga necessária<br>Behöver laddas upp |

- |   |   |   |
|---|---|---|
|   |   |   |
| Ready to pair<br>Bereit zum Abstimmen<br>Listo para emparejar<br>Prête pour le jumelage<br>Pronto per il pairing<br>Pronto para emparelhar<br>Klar för synkronisering | Connecting<br>Verbinden<br>Conectando<br>Connexion en cours<br>Connessione in corso<br>Conectando<br>Ansluter | Connected<br>Verbunden<br>Conectado<br>Connexion établie<br>Connesso<br>Conectado<br>Ansluten |

